

## THC-T350-Z 5 MP Turret Camera

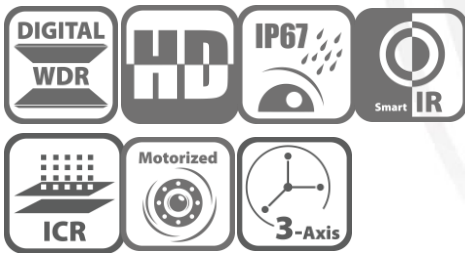

- 5 MP high performance COMS
- 2560 × 1944 resolution
- 2.7 mm to 13.5 mm motorized vari-focal lens
- EXIR 2.0, smart IR, up to 40 m IR distance
- OSD menu, 2D DNR, DWDR
- 4 in 1 video output (switchable TVI/AHD/CVI/CVBS)
- IP66
- Up the coax (HIKVISION-C)

## Specification

Camera	
Image Sensor	5 MP CMOS image sensor
Resolution	2560 (H) × 1944 (V)
Min. Illumination	Color: 0.01 Lux @ (F1.2, AGC ON), 0 Lux with IR
Shutter Time	PAL: 1/25 s to 1/50, 000 s NTSC: 1/30 s to 1/50, 000 s
Lens	2.7 mm to 13.5 mm motorized vari-focal lens
Horizontal Field of View	95.7° to 29.1°
Lens Mount	Φ 14
Day & Night	IR cut filter
Angle Adjustment	Pan: 0° to 360°; Tilt: 0° to 75°; Rotate: 0° to 360°
Synchronization	Internal synchronization
Frame Rate	PAL: 5 MP@20fps, 4 MP@25fps, 1080p@25fps NTSC: 5 MP@20fps, 4 MP@30fps, 1080p@30fps
Menu	
AGC	Support
D/N Mode	Auto/Color/BW (Black and White)
White Balance	ATW/MWB
BLC	Support
DWDR (Digital Wide Dynamic Range)	Support
Functions	Brightness, Sharpness, DNR, Mirror, Smart IR
Interface	
Video Output	1 HD analog output
Switch Button	TVI/AHD/CVI/CVBS
General	
Operating Conditions	-40 °C to 60 °C (-40 °F to 140 °F), humidity: 90% or less (non-condensation)
Power Supply	12 VDC ±25%
Power Consumption	Max. 6.3 W
Protection Level	IP67
Material	Metal
IR Range	Up to 40 m
Communication	Up the coax, Protocol: HIKVISION-C (TVI output)
Dimensions	Ø135.78 mm × 236.41 mm (5.35" × 4.65")
Weight	Approx. 580 g (1.28 lb.)

## Available Model

THC-T350-Z

## Dimension

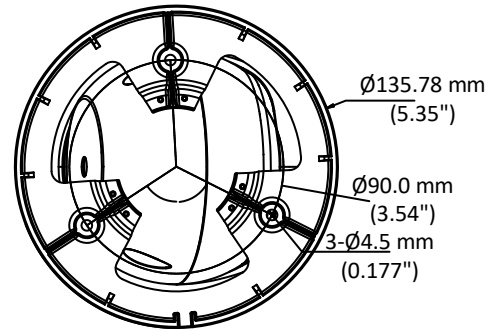
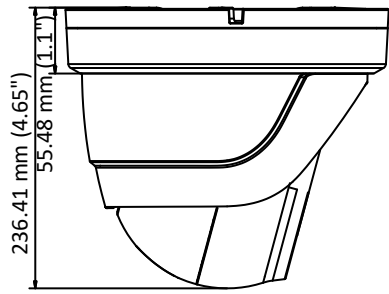

## Accessory



**HIA-J103**  
Junction Box



**HIA-B301**  
Vertical Pole Mount



**HIA-B201**  
Corner Mount



**HIA-B402-130T**  
Wall Mount

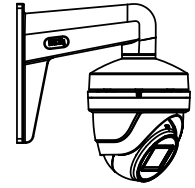
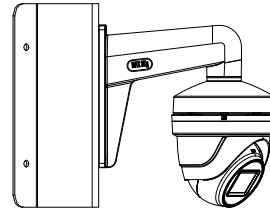
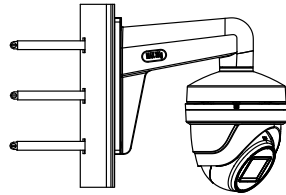
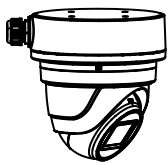

**HIA-J202**  
Inclined Ceiling Mount

