

LPCB APPROVED
CFP 2/4/8 ZONE
FIRE ALARM
CONTROL PANEL

**installation &
maintenance
manual**

Approved Document No. DFU7004010 Rev 1



CONTENTS

EN54 Compliance Statement	3
Basic Overview & Key Features	3
Important Notes	4
The Fire Panel Enclosure	5
First Fix	6
Cable types and limitations	6
Mains wiring	6
Planning the cable layout in the panel	6
Fixing the base to the wall	7
Typical detector circuit wiring	7
Typical sounder circuit wiring	8
Typical auxiliary input wiring	8
Typical auxiliary output wiring	9
Second Fix	10
Connecting the panel	10
Installing the Power Supply PCB	10
Connecting the Mains	10
Connecting the standby batteries	10
Installing the Main Control PCB	12
Connecting the detector and sounder circuits	13
Connecting the auxiliary inputs, auxiliary outputs and relay outputs.....	13
Programming the Panel	14
An overview of the panel's controls	14
Engineer functions.....	14
Accessing the engineer controls	16
Programming coincidence, non-latching zones, delays, zones into test, sounder functions	16-17
Fault Diagnosis	18
Fault indications	18
Zone faults	19
Power supply faults	19
System faults	21
Repeater faults.....	22
Sunder faults	22
Remote output faults	22
Maintenance	22
Standby Battery Calculation Guide	23
Technical Specification	24

Errors & Omissions Excepted. The manufacturer of this product operates a policy of continuous improvement and reserves the right to alter product specifications at its discretion and without prior notice. All of the instructions covered in this manual have been carefully checked prior to publication. However, no responsibility can be accepted by the manufacturer for any inaccuracies or for any misinterpretation of an instruction or guidance note.

EN54 COMPLIANCE STATEMENT

This fire alarm panel is fully compliant with the requirements of EN54 Part 2 (Fire detection and fire alarm systems, control and indicating equipment) and EN54 Part 4 (Fire detection and fire alarm systems, power supply equipment) and is certified as meeting these standards by the Loss Prevention Certification Board (LPCB) - unless stated.



Please note, some of the engineering functions provided on the panel go beyond the scope of EN54 Part 2. A caution symbol (left) is used to indicate where such a function is **non-compliant with EN54-2**. DO NOT affix the LPCB approval label (supplied) to the front of the panel if it has been configured to operate in a way that would make it non-compliant with the requirements of EN54-2.

BASIC OVERVIEW & KEY FEATURES

The fire alarm panel features include the following:

- Two, four or eight detector circuits (dependent on the model purchased);
- Four conventional sounder circuits;
- A flush or surface mountable plastic lid and enclosure;
- A wide range of secure user functions (as detailed in the separate User Manual/Log Book) including the ability to disable/enable a large number of system functions, as specified in EN54;
- Keypad and keyswitch entry to access authorised user controls (access level two);
- A wide range of engineering functions, including:

Selectable zone delay facility

Non-latching zones facility. **Note: This function is non-compliant with EN54-2.**

Coincidence (double-knock) facility. **Note: This function is non-compliant with EN54-2.**

Zone test facility

Programming silenced sounders to resound, or not resound, when new zone in alarm

Comprehensive fault diagnostic facilities



- The following optional EN54 Part 2 features:

Output(s) to fire alarm devices {Clause 7.8}. Four conventional sounder circuits are provided to drive external alarm sounders.

Delays to outputs {Clause 7.11}. A delay facility (selectable on a zone by zone basis) is provided to delay the alarm sounders, remote fire and/or auxiliary outputs.

Test condition {Clause 10.0}. A zone test facility is provided.

- The following features that are not required by EN54 Part 2:

Reset output (RESET) open collector output which provides a signal to reset any part of the fire alarm system (if required) whilst the panel is being reset.

Remote output (REM) open collector output and Auxiliary fire relay output (AUX) which provide a signal to any part of the fire alarm system that needs to be activated during a fire alarm condition.

Two (non-latching) auxiliary input connections; 'class change' and 'alert'.

- A Fault relay output (FAULT).

IMPORTANT NOTES



This equipment must only be installed and maintained by a suitably skilled and technically competent person.
THIS EQUIPMENT IS A PIECE OF CLASS 1 EQUIPMENT AND MUST BE EARTHED.

Items supplied with this panel

- Installation & Maintenance Manual (i.e. this manual).
Explains how to install, commission and maintain the fire alarm control panel.
This manual must not be left accessible to the User.
- User Manual / Log Book.
Gives detailed operational information, some of which will need to be referenced by the installation engineer when setting up the panel. Sections of the user manual must be completed by the engineer before system handover.
- Torx key, for unfastening / securing the panel lid.
- Electrical accessory pack, containing the following items:
 - 8 x 0.47 μ F 50V capacitors
 - 4 x 6K8 0.25W resistors
 - 1 x Mains fuse
 - 1 x battery connection kit
 - 2 x nylon cable ties (for securing the batteries into the panel enclosure)
 - 1 x LPCB approval label (see EN54 Compliance Statement, page 3 for details).

System design

Fire alarm system design is beyond the scope of this document. A basic understanding of fire alarm system components and their use is assumed.

We strongly recommend that a suitably qualified and competent person is consulted in connection with the design of the fire alarm system and that the system is commissioned and serviced in accordance with the laid down specification and national standards. The fire officer concerned with the property should be contacted at an early stage in case he/she has any special requirements.

We recommend you read BS 5839 Part 1: Fire detection and fire alarm systems for buildings - code of practice for system design, installation, commissioning and maintenance, available at your local reference library or from the BSI. Other national standards of installation should be referenced and adhered to where applicable.

Equipment guarantee

This equipment is not guaranteed unless the complete system is installed and commissioned in accordance with the laid down national standards by an approved and competent person or organisation.



This product has been manufactured in conformance with the requirements of all applicable EU Council Directives.

THE FIRE PANEL ENCLOSURE

The panel is supplied with a plastic detachable lid, a plastic back box and a minimum of two separate PCBs. The relative location of these PCBs is indicated in figure 1 below.

The panel can be surface or semi-flush mounted. It **must** be sited indoors in an area **not** subject to conditions likely to affect its performance, e.g. damp, salt-air, water ingress, extremes of temperature, physical abuse, etc. It should be sited at a height where it is easily accessible and in a prominent position within the building. Ideally, the indicators on the front of the enclosure should be at eye level.

Typical locations for the panel are in the entrance foyer/hallway of a building at ground floor level (the first and most obvious point of contact for emergency services) or a security office that is likely to be permanently manned.

Removing the lid and base PCBs

To protect the electronics from damage and to expose the base mounting holes, the panel's lid and PCBs should be removed prior to first fix installation.



Anti-static handling guidelines

Please ensure that the following electro-static handling precautions are taken immediately prior to handling the panel's PCBs or any other static-sensitive components:

Before handling any static-sensitive items, operators should rid themselves of any personal electro-static charge by momentarily touching any sound connection to safety earth, e.g. a radiator. Always handle PCBs by their sides and avoid touching the legs of any components. PCBs should be stored in a clean, dry place which is free from vibration, dust and excessive heat. Retaining the PCBs in a suitable cardboard box will also guard them against mechanical damage.

Figure 1 : Location of the panel's base PCBs and removal details

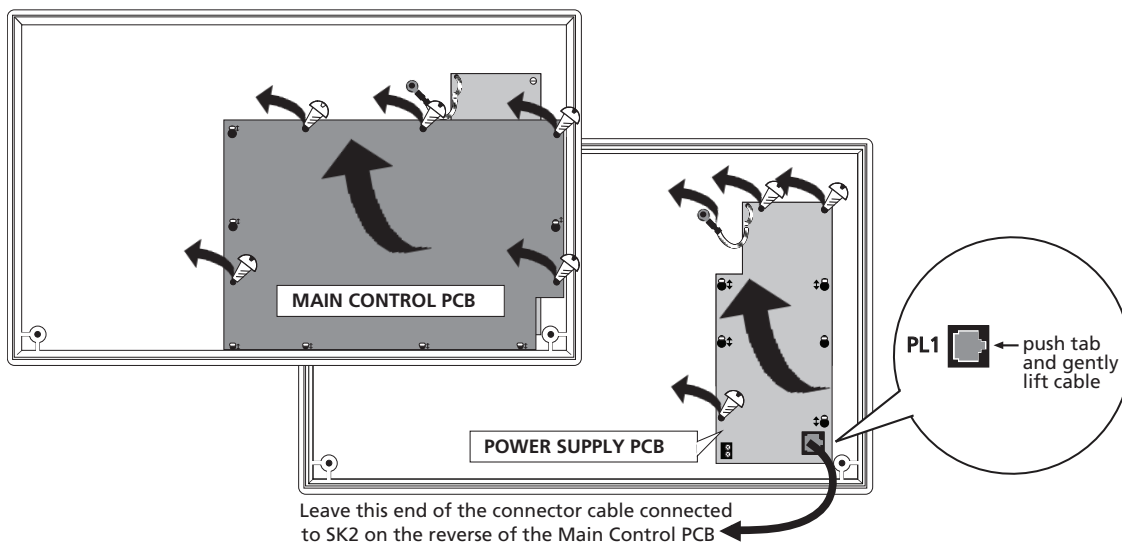

1. Take the fire alarm panel out of its box and undo the two lid screws using the Torx key provided. Remove the lid to expose the Main Control PCB (the Power supply PCB is located underneath).
2. Carefully remove the five retaining screws on the Main Control PCB and slide the PCB up and over the mounting pillars, taking care not to damage any of the components.
3. Disconnect the telecoms-style connecting cable at PL1 on the Power Supply PCB, making sure that the cable remains connected to the reverse of the Main Control PCB to prevent it being misplaced. Care should be taken when detaching this connector to depress the locking tab to prevent damage.
4. Pull the Power Supply's earth strap off the spade connector at the main chassis earth point.
5. Carefully remove the three retaining screws on the Power Supply PCB and slide the PCB up and over the mounting pillars, again taking care not to damage any of the components.

FIRST FIX

All system wiring should be installed to meet BS 5839 Part 1 and BS 7671 (Wiring Regulations). Other national standards of installation should be used where applicable.

Cable types and limitations

Consult Clause 26 of BS 5839 Part 1: Fire detection and fire alarm systems for buildings - code of practice for system design, installation, commissioning and maintenance, for detailed information on cables, wiring and other interconnections.

To comply with EMC (Electro Magnetic Compatibility) regulations and to reduce the risk of electrical interference in the system wiring, we recommend the use of fire-resistant screened cables throughout the installation. Cables such as FP 200, Firetuff™, Firecel™ and MICC may be acceptable provided they are properly terminated at the fire panel and meet national standards/the system specification as applicable.

Correct cable glanding is essential and due regard should be made to any system specifications which demand a certain cable type.

Mains wiring

The requirement for the Mains supply to the fire panel is fixed wiring, using three core cable (no less than 1mm² and no more than 2.5mm²) or a suitable three conductor system, fed from an isolating switched fused spur, fused at 3A. This should be secure from unauthorised operation and be marked 'FIRE ALARM: DO NOT SWITCH OFF'. The Mains supply must be exclusive to the fire panel.

(As an alternative to a switched fused spur, a double pole isolating device may be used providing it meets the appropriate national wiring regulations - see diagram below.)

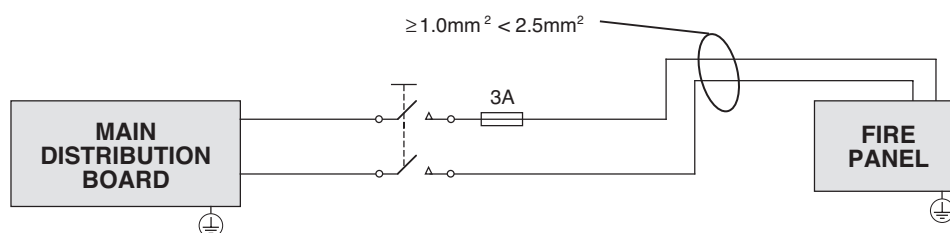

Planning the cable layout in the panel

The detector and sounder circuit cabling is classed as extra low voltage and should be segregated away from Mains voltages. Careful planning is needed to ensure this, see figure 2 (below) for guidance. Drill centre points are provided in the panel base to aid drilling tools. Cut out suitable holes in the panel using a hole saw directed by a pilot bit in the centre of the hole saw. Always ensure that if a hole is cut out it is filled with a good quality cable gland. Any unused holes must be securely blanked off.

Figure 2 : Location of centre points for hole removal

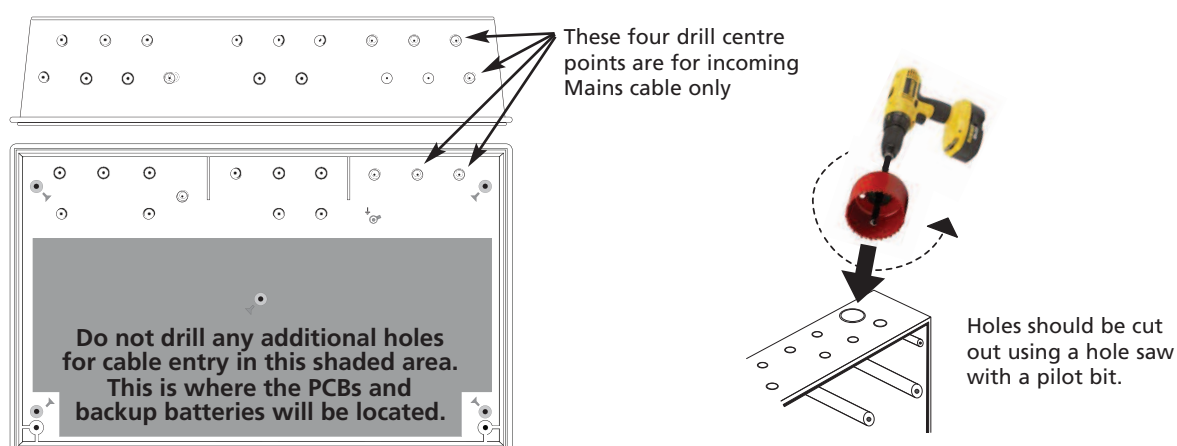

CFP 2/4/8 ZONE LPCB APPROVED FIRE ALARM PANEL

Fixing the base to the wall

Using the five mounting holes provided (see figure 3 below), fix the base securely onto/into the wall. The mounting holes are suitable for use with No.8-10, or 4-5mm countersunk screws.

Assess the condition and construction of the wall and use a suitable screw fixing.

Any dust or swarf created during the fixing process must be kept out of the fire alarm panel and care must be taken not to damage any wiring or components.

Figure 3 : Internal view of the back box with PCBs removed / side view for flush mounting

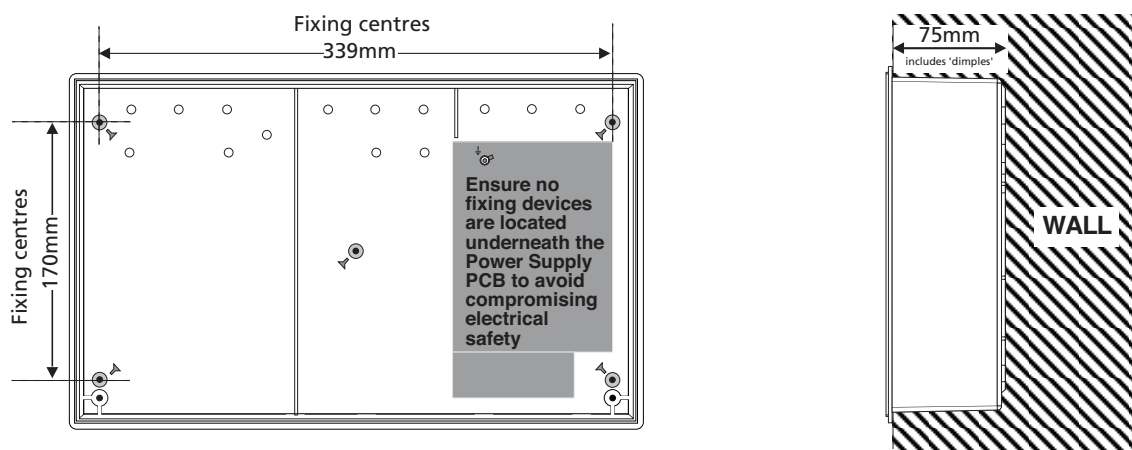

Typical detector circuit wiring

Depending on the model purchased, two, four, or eight detector circuit connections are available on the fire alarm panel.

Refer to the specification on page 24 for the maximum number of devices that may be fitted to each circuit. **Note:** The number of devices affects the standby time of the system, and this should be taken into consideration when selecting the standby batteries. See page 23 for more information.

Figure 4 : Typical detector circuit wiring

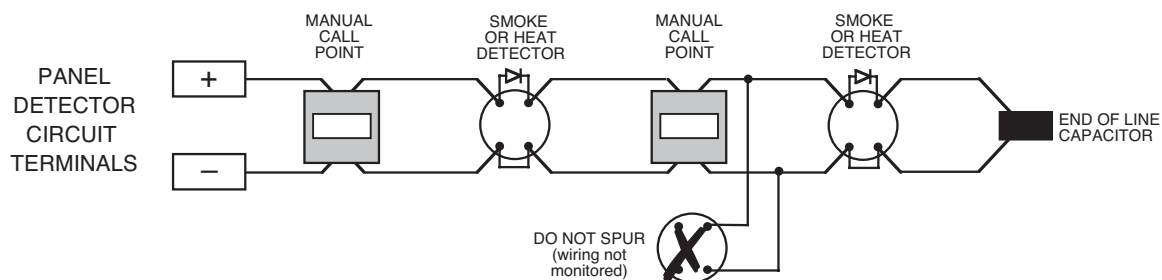

Connect an end-of-line (EOL) capacitor (provided in the panel's accessory pack) across the terminals of the last device on each circuit to allow the wiring to be monitored.

Detector bases with integral continuity diodes must be used to ensure manual call points remain operational when a detector head is removed from its base.

Manual call points with integral resistors must be used to prevent a short circuit fault occurring instead of a fire condition when activated.

For more specific device wiring information, please refer to the manufacturers' own instructions.

The wiring for each detector circuit should be connected to the relevant 5mm connector block on the Main Control PCB and their screens terminated at the panel's base earth post (see page 13 for detailed second fix connection information).

CFP 2/4/8 ZONE LPCB APPROVED FIRE ALARM PANEL

Typical sounder circuit wiring

Four conventional sounder circuits are available on the fire alarm panel. These can accommodate up to 40 polarised sounders (at 20mA) or 32 bells (at 25mA) per system. If a full complement of sounders or bells are to be used, they should be split as equally as possible across all four sounder circuits.

Figure 5 : Typical sounder circuit wiring

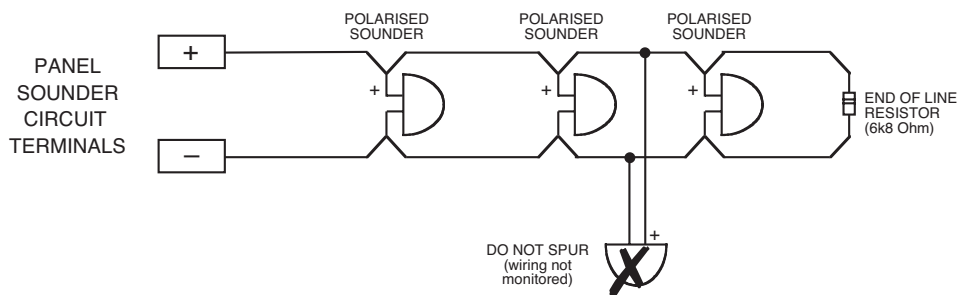

All sounders must be polarised as unpolarised sounders will show a sounder fault. A 6k8 end-of-line resistor (provided in the panel's accessory pack) must be connected at the end of each sounder circuit to allow the wiring to be monitored.

The wiring for each sounder circuit should be connected to the relevant 5mm connector block on the Main Control PCB and their screens terminated at the panel's base earth post (see page 13 for detailed second fix connection information).

Typical auxiliary input wiring

Two non-latching auxiliary input connections are available on the panel, as detailed below:

- Alert Input (ALERT):** Operates the sounders intermittently when connected to 0V.
- Class Change Input (CC):** Operates the sounders continuously when connected to 0V.

If either of the above are triggered, they WILL NOT operate the panel's remote or auxiliary fire outputs.

Figure 6 : Typical auxiliary input wiring

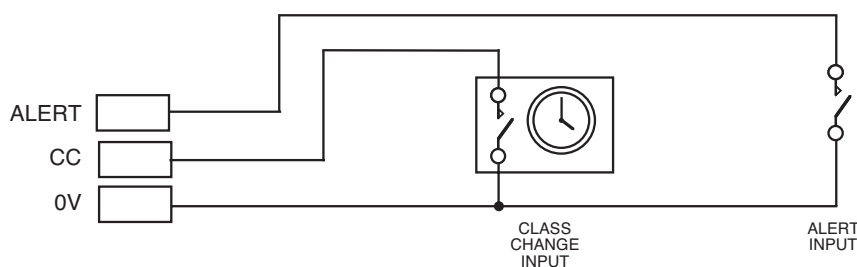

Connect the wiring for each input to the relevant 5mm connector block on the Main Control PCB and terminate their screens at the panel's base earth post (see page 13 for more details).

CFP 2/4/8 ZONE LPCB APPROVED FIRE ALARM PANEL

Typical auxiliary output wiring

Two auxiliary open collector outputs and one auxiliary output connections are available on the panel, as detailed below:

Reset Output (RESET)	Turns on during the panel's reset cycle. Can be used for resetting fire alarm system devices such as roller-shutter doors or beam detectors. This output remains active for approximately one second after all other outputs have returned to normal.
Remote Output (REM)	Turns on during any new fire alarm condition or when the panel's Silence/Resound Sounders button is pressed to manually evacuate the building. The output turns off when the panel is silenced. This output <u>does not</u> turn on when the Class Change or Alert inputs are asserted (unless there are other fire alarm conditions present on the system). Note: It is possible to delay the activation of the Remote Output to correspond with any zone delay(s) that have been programmed into the panel at Access Level 3. If required, the remote output can be disabled by the user. When the Remote output is activated the Remote Output light will be lit. This output will not operate from a non-latching zone.
Auxiliary 24V Output (AUX 24V)	This output provides a positive voltage supply for peripheral loads (such as relays) which are controlled from the above outputs. It is protected by a current limiting fuse which trips if one or more of the loads are shorted. This affects all loads and results in appropriate faults being reported at the panel. The current consumed by this output <u>must</u> be considered when calculating battery standby times. DO NOT CONNECT DOOR HOLDER CIRCUITS TO THIS OUTPUT AS THEY WILL REDUCE BATTERY STANDBY TIME - USE A SEPARATE POWER SUPPLY.

Figure 7 : Typical auxiliary output wiring for open collector outputs

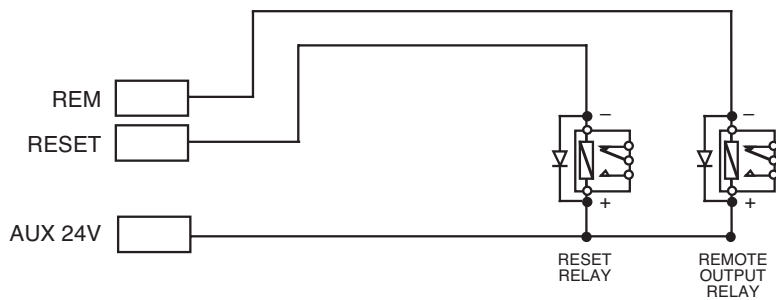

To protect the output stage, only 24V polarised relays with back EMF diodes should be used. If any of the relays are to be used to switch Mains potentials, then suitable relays should be chosen and installed and wired accordingly, so as not to compromise the electrical safety of the fire alarm system.

Two relay outputs are available on the panel, as detailed below:

Auxiliary Fire Output (AUX)	Turns on during any fire alarm condition and off when the panel is reset. This output <u>does not</u> turn on if the Class Change or Alert inputs are asserted, or if the panel's Silence/Resound Sounders button is pressed to manually evacuate the building (unless there are other fire alarm conditions present on the system). Note: It is possible to delay the activation of the Auxiliary Output to correspond with any zone delay(s) that have been programmed into the panel at Access Level 3. If required, the Auxiliary Output can be disabled by the user. This output will not operate from a non-latching zone.
Fault Output (FAULT)	<u>This output is normally energised.</u> When a fault occurs, the output turns off to ensure failsafe operation even in the event of total power loss. It is important that the peripheral part of the system this output drives is able to handle the output's 'normally on' condition. If required, this output can be disabled by the user.

Connect each output to the relevant 5mm connector block on the Main Control PCB and terminate their screens at the panel's base earth post (see page 13 for more details).

SECOND FIX

Connecting the panel

Connecting the panel's internal connections and PCBs should be undertaken immediately before commissioning.

Before you begin, we recommend you check all devices on the detector and sounder circuits are correctly connected (see pages 7 and 8) and that cable integrity is verified throughout the installation.

Important: DO NOT use a high voltage insulation tester with any electronic devices connected.

Faults occurring in the wiring which are not picked up at this stage will almost certainly result in spurious and intermittent faults when the equipment is energised.

Installing the Power Supply PCB

The panel's Power Supply PCB combines the functions of a Mains to dc switched mode power supply unit, battery charging unit and battery monitoring unit.



WHEN CONNECTED, THE POWER SUPPLY PCB STORES VOLTAGES AT UP TO 400Vdc AND MAY BE LETHAL IF TOUCHED. DO NOT TOUCH THE PCB WHILST THE RED 'HAZARDOUS VOLTAGES PRESENT' INDICATOR IS LIT.

Under no circumstances should the fire alarm panel be operated without the Power Supply PCB correctly mounted in the panel's enclosure and the three retaining screws securely tightened.

The PCB should be positioned in the panel as shown in figure 8 on page 11.

Connecting the Mains

The general requirement for the Mains supply to this equipment is described on page 6.

DO NOT attempt to connect Mains to the panel until you are fully conversant with the layout and features of the Power Supply PCB, as described above and in figure 8 on page 11.

The incoming Mains cable should be brought into the panel at the top right hand side of the enclosure and terminated at the connector block (CONN1) on the Power Supply PCB.

Make sure the Mains earth wire is connected directly to this connector block and NOT to the secondary base earth post which is provided for making off detector and sounder circuit screens.



The Power Supply PCB's earth strap MUST be connected to the spade on the chassis earth post before operation. The spade is compressed against a shoulder on the post via the lowest nut. The earth post may appear loose, this is intended by design.

Connecting the standby batteries

Two new, good quality and fully charged 12V valve regulated lead acid (VRLA) batteries are required as the emergency standby power supply for the panel. **Caution:** DO NOT use any other type of batteries due to the risk of explosion.

The batteries should be connected in series and located in the panel's enclosure as shown in figure 9 on page 11. The battery leads, link wire and nylon cable ties are provided in the panel's accessory pack. Run the battery leads through the slits in the panel's lower plastic ribs and secure the batteries into position using the nylon cable ties as shown.

The panel's sophisticated battery monitoring unit protects the batteries against deep discharge by activating a cut off circuit when the standby supply voltage reaches 21V approx. If batteries are not fitted, are discharged or in poor condition, a PSU fault will show at the fire alarm panel.

The capacity of the batteries used will depend upon the required standby time. To calculate the batteries required for any given standby period, please refer to the calculation guide on page 23.

Always dispose of used batteries according to the battery manufacturer's instructions.

CFP 2/4/8 ZONE LPCB APPROVED FIRE ALARM PANEL

Figure 8 : Power Supply PCB layout and Mains connection details

Incoming Mains cable must be segregated from other cables and should only enter the panel through either of these drill outs. Good quality cable glands must always be fitted.

PSU earth strap

Do not operate the panel without this strap connected.

Mains fuse (F1)

20 x 5mm 1A HRC ceramic to IEC 127 (EN60127 Part 2). Do not use any other type or size of fuse in this position.

Battery fuse (F2)

20 x 5mm 1A6 F to IEC 127 (EN60127 Part 2). Do not use any other type or size of fuse in this position.

Battery leads

(supplied in the panel's accessory pack). See below for connection details.

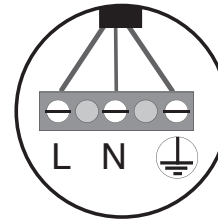
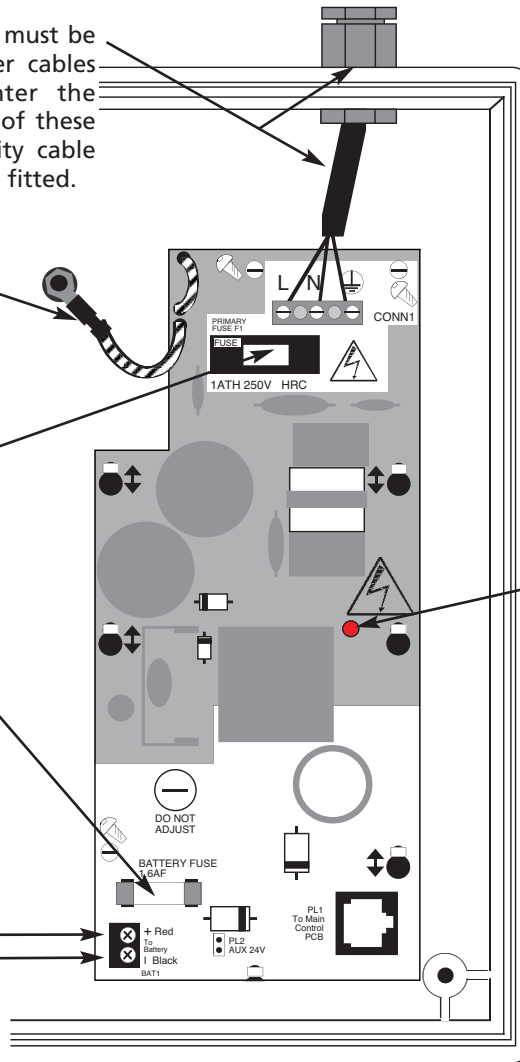

CONN1

L = Live; N = Neutral; ⚡ = Earth.

The incoming Mains earth wire must be connected to the terminal marked ⚡ and not to the base earth post. (The PSU earth strap connects the PCB to the base earth post.)

Hazardous Voltages Present light

When lit red, hazardous voltages will be present on the components in the shaded area of the PCB.

DO NOT TOUCH!



Certain components are charged to this hazardous voltage during operation, and this charge is bled away after the Mains supply has been removed. When the red light extinguishes, the charge has leaked away to a safe level.

Figure 9 : Battery location and connection details

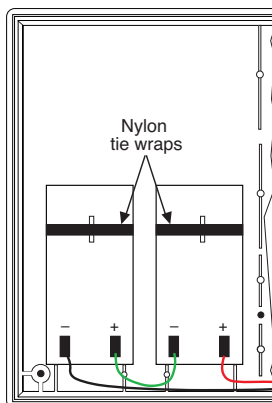

Location of small sized batteries typically 1.2 Ah

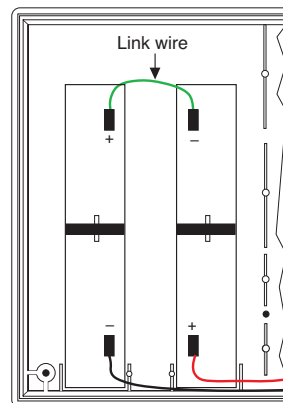

Location of medium sized batteries typically 2.1 Ah

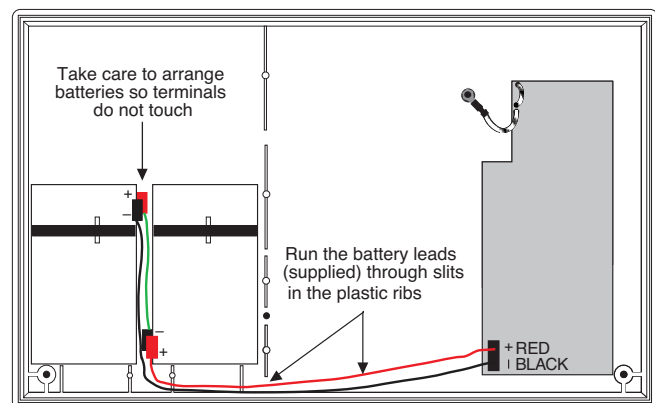

Connection of leads to Power Supply PCB

CFP 2/4/8 ZONE LPCB APPROVED FIRE ALARM PANEL

Installing the Main Control PCB

The panel's Main Control PCB provides all the connections for the system's detector circuits, sounder circuits, auxiliary inputs and auxiliary outputs. It also provides the engineer with access to a wide range of engineering functions, details of which appear later in this manual.

Before any connections can be made, the Main Control PCB must first be securely positioned inside the fire alarm panel (see figure 10 below) using the five retaining screws. As the PCB is presented to the panel, remember to attach the telecoms-style connecting cable to SKT2 on the reverse of the Main Control PCB and to PL1 on the Power Supply PCB.

Important: SKT1 on the reverse of the Main Control PCB is for the connection of optional system expansion devices such as Network Driver Cards (for repeater panels) and Relay Output Boards. If any of these devices are to be used, refer to the individual installation instructions supplied with them as they will need to be fitted to the panel before the Main Control PCB.

All of the 5mm connector blocks located across the top of the PCB can be removed to aid installation. Take care when reconnecting them that you do so the correct way round. We recommend that you clearly label all system wiring to reduce the likelihood of incorrect connection.

Figure 10 : Main Control PCB layout

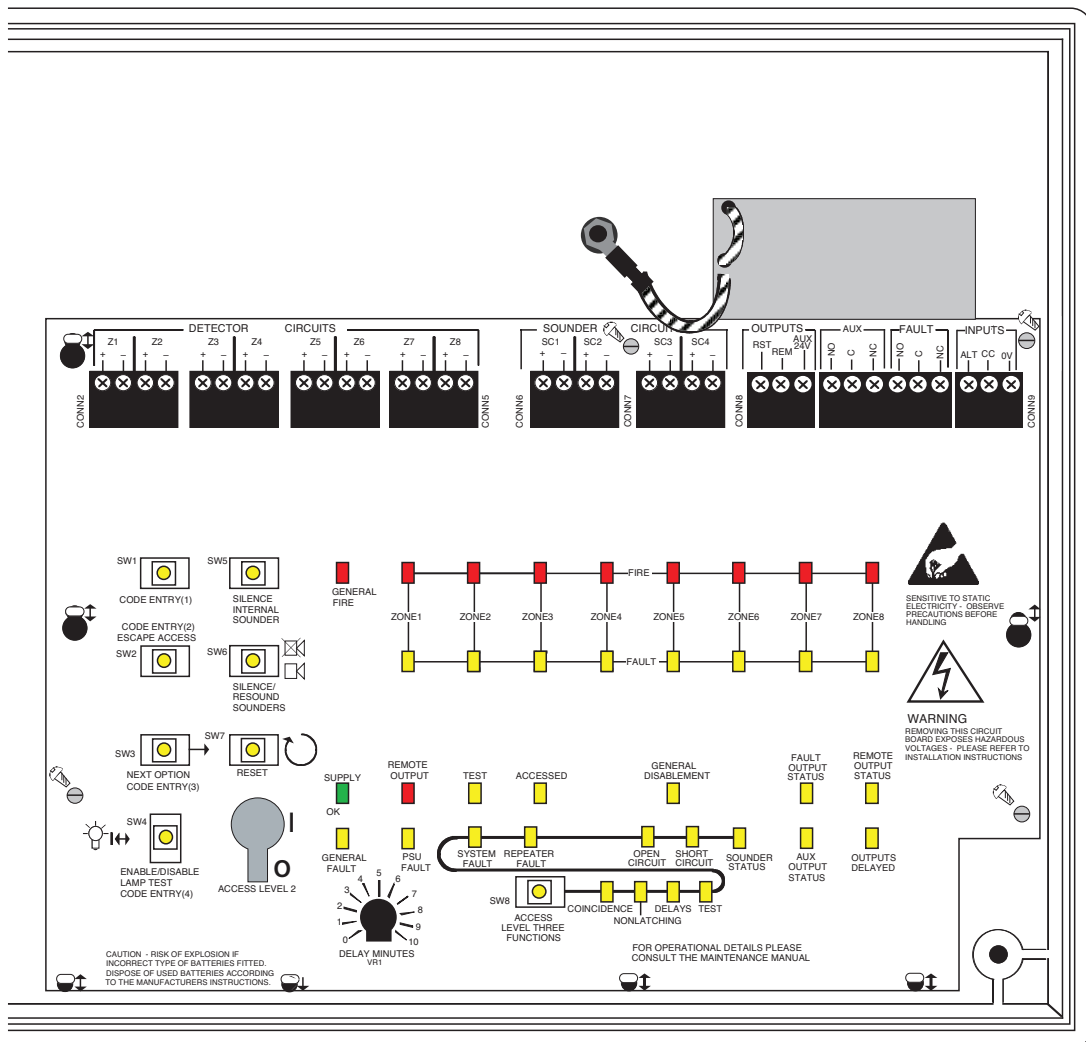

CFP 2/4/8 ZONE LPCB APPROVED FIRE ALARM PANEL

Connecting the detector and sounder circuits

Incoming detector and sounder circuits should be connected to the relevant connector block on the Main Control PCB as shown in figure 11 below.

For typical detector and sounder circuit wiring diagrams, please refer to pages 7 and 8.

Figure 11 : Detector and sounder circuit connection

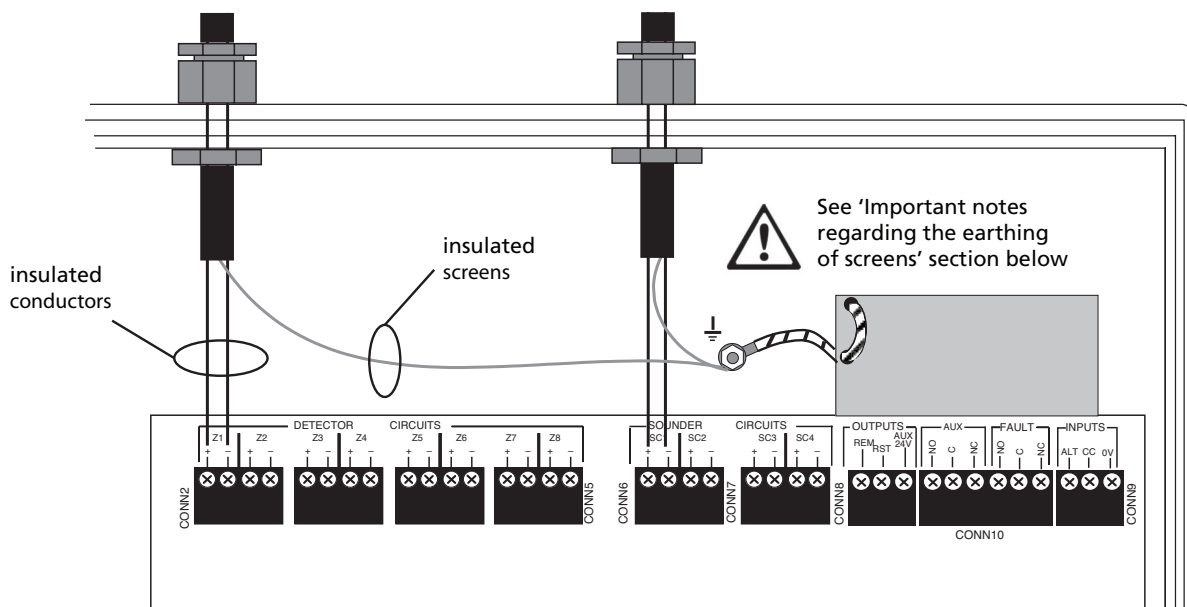

Connecting the auxiliary inputs, auxiliary outputs and relay outputs

Incoming auxiliary inputs, auxiliary outputs and relay outputs cables should be connected to the relevant connector block terminals on the Main Control PCB. If screened cables have been used, all screens should be adequately insulated and connected between the nut and washers on the base earth post (see below) using eyed crimp connectors (as per the detector and sounder circuit examples shown in figure 11).

For a full description of the inputs and outputs available on the panel, including typical wiring diagrams, please refer to pages 8 & 9.

Important notes regarding the earthing of screens



All screens should be adequately insulated and connected between the nut and washers on the base earth post (see right) using suitable eyed crimp connectors. **Do not disturb the lower nut, this must be secure to ensure earth continuity.** The base earth post is provided for terminating earth screens or drains and not as the main earthing point. The system designer or installer must review the external earth bonding (if required) with respect to the national wiring rules. That is, if the type of installation requires protective earth bonding, then this must be applied externally and in conjunction with the type of earthing system employed on that particular site. This must always be done with regard to the appropriate national wiring rules.

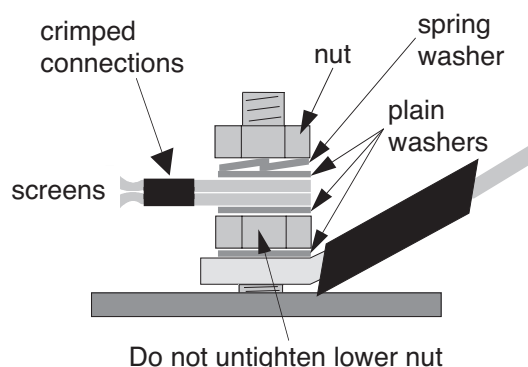

PROGRAMMING THE PANEL

An overview of the panel's controls

Three control levels are available on the panel - general user (access level one), authorised user (access level two) and engineer (access level three), as detailed below:

General user controls (access level one)

When the panel is in its normal state, the indicator lights on the panel front give a comprehensive overview of the system's current status. Any fire and fault conditions are clearly displayed, disablements highlighted and the status of all outputs reported. The only functions that can be performed when the panel is in this state are:

- Muting the panel's internal sounder.
- Overriding any delays which may have been programmed into the panel.
- Putting the panel into access level two to make active the authorised user controls (see below).

Authorised user controls (access level two)

To avoid unauthorised changes to critical parts of the fire alarm system, certain fire alarm panel controls are only available to authorised users. These include:

- Silencing the sounders.
- Resetting an alarm condition.
- Manually activating the alarm sounders (to evacuate a building)
- Testing the indicator lights.
- Disabling or enabling any (or all) of the following: zones, sounders, the fault output, the remote output, the auxiliary fire output and delays.

The authorised user controls can be accessed by entering the code **2 1 4 3** using the keypad or, by turning the keyswitch to the 'I' position.

For detailed information on how to use the general and authorised user controls, please refer to the User Manual / Log Book.

Engineer controls (access level three)

It is possible to read or interrogate the site specific data at this level. The following controls are available to competent service personnel only:

- The programming of coincidence / double-knock. **Note: This function is non-compliant with EN54-2.**
- The setting-up zones for non-latching operation. **Note: This function is non-compliant with EN54-2.**
- The programming of delays.
- The invoking of test procedures.
- Programming silenced sounders to resound, or not resound, when new zone in alarm.
- Fault diagnosis.



A brief overview of these functions appears below. Details of how to gain access to the engineer controls and how to use them appears on pages 16 and 17. We recommend, however, that you carefully read the sections below before attempting to implement any changes to the factory defaults or existing system set-up.

Engineer functions

Coincidence (Note: This function is non-compliant with EN54-2)



The programming of coincidence (also referred to as 'double-knock') is a feature often used on sites where the consequence of a false alarm can be onerous, e.g. where the panel is used to trigger a sprinkler, or gas extinguishant system.

Coincidence is programmed into the panel in pairs of zones, the pairs being zones 1 and 2; zones 3 and 4 (if fitted), zones 5 and 6 (if fitted); and zones 7 and 8 (if fitted).

When any of these pairs are programmed to operate in coincidence mode, there must be alarms on both zones before the sounders and outputs are turned on. If only one of the pair goes into alarm, the panel will indicate the alarm condition by illuminating the relevant light on the front panel and activating its internal sounder, thus prompting the user to investigate.

If found to be false, the alarm can be reset by the user. If found to be a true fire condition, the user can manually activate the alarm sounders and outputs by entering access level two and pressing the SILENCE/RESOUND SOUNDERS button.

CFP 2/4/8 ZONE LPCB APPROVED FIRE ALARM PANEL

From an installation point of view, detectors on zones assigned for coincidence should be installed in close proximity to each other. This ensures if the user is not around to investigate the cause of the alarm, that a detector in alarm on one zone is quickly confirmed by its neighbour on the corresponding zone in the event of a real fire. Alarms raised in zones not set up for coincidence will be processed as normal.

Non-Latching Zones (Note: This function is non-compliant with EN54-2)



Any or all of the zones on the fire alarm panel can be set up for non-latching operation.

Alarms raised from non-latching zones are indicated as normal but when the alarm stimulus that triggered the zone is cleared, the alarm condition at the panel automatically clears too (i.e. a manual panel reset is not required).

Note: Alarms raised on non-latching zones will not trigger the panel’s auxiliary fire and remote outputs.

Non-latching zones are often used to interconnect fire panels to prevent a ‘deadly embrace’ situation. This is a permanent unresettable alarm condition arising from multiple fire panels simultaneously flagging latching alarm conditions.

Delays

A delay of 1 to 10 minutes can be set between the fire alarm panel being triggered to its alarm sounders and outputs being activated. This is a particularly useful feature in public places where the nuisance and panic caused by a false alarm must be avoided.

The delay period is set by adjusting the VR1 control on the Main Control PCB (see right) with a terminal screwdriver. **Note:** The delay period will apply to all delayed zones.



Use a small terminal screwdriver to adjust the length of the Delay period. For information on how to assign individual zones so the delay period applies to them see pages 16 and 17.

When an alarm occurs on a delayed zone, it is processed as normal. However, the activation of the sounders and outputs is postponed until the delay period has expired, thus allowing the cause of the alarm to be investigated by the user.

During the delay period, the Output Delays light on the panel front pulses to indicate the delay is operative. Pressing the SILENCE/RESOUND SOUNDERS button will override the delay at any time and result in the sounders and outputs being turned on. Pressing the panel’s reset button during a delay period (i.e. in the event of a false alarm) will return the system to normal.

Test

To aid commissioning and routine maintenance checks, a non-latching ‘one man walk test’ facility is available.

When a detector or manual call point is triggered on any zone(s) in test, the alarm sounders operate for approximately one second on and eight seconds off. This cycle continues until the cause of the alarm is removed (either by the test smoke clearing from the detector or the manual call point being reset), at which point the detector circuit also automatically resets. As the engineer walks around the site, additional devices on the zone(s) in test can be checked with the momentary activation of the alarm sounders confirming correct operation.

Zones programmed for test, will be indicated at the panel by their fault lights pulsing quickly in synchronisation with the General Test light.

Should an alarm occur on a zone that is not programmed for test, the alarm will be processed in the normal way. All zones that are in test will have their tests temporarily suspended until the alarm(s) from the other zones are reset. At this point zone testing may resume. In other words, the alarm will operate correctly despite being in test mode.

Program the sounders function

Once the sounders have been activated after an alarm, then silenced, it is possible to set up the panel so that a new alarm raised from another zone resounds, or does NOT resound, the sounders in accordance with EN54-2 {Clause 7.8d}.

Fault diagnosis

A wide range of fault diagnosis features are available at access level three. These are described in detail on pages 18 to 22 of this manual.

CFP 2/4/8 ZONE LPCB APPROVED FIRE ALARM PANEL

Accessing the engineer controls

Before programming the panel, please refer to pages 14 and 15 for an overview of the various engineering functions available and the effect their implementation will have on the way the system operates.

To gain access to the panel's engineer functions, remove the panel lid using the Torx key provided and press the ACCESS LEVEL THREE FUNCTIONS button on the Main Control PCB (see figure 12 below).

Figure 12 : Location of the panel's programming tools on the Main Control PCB

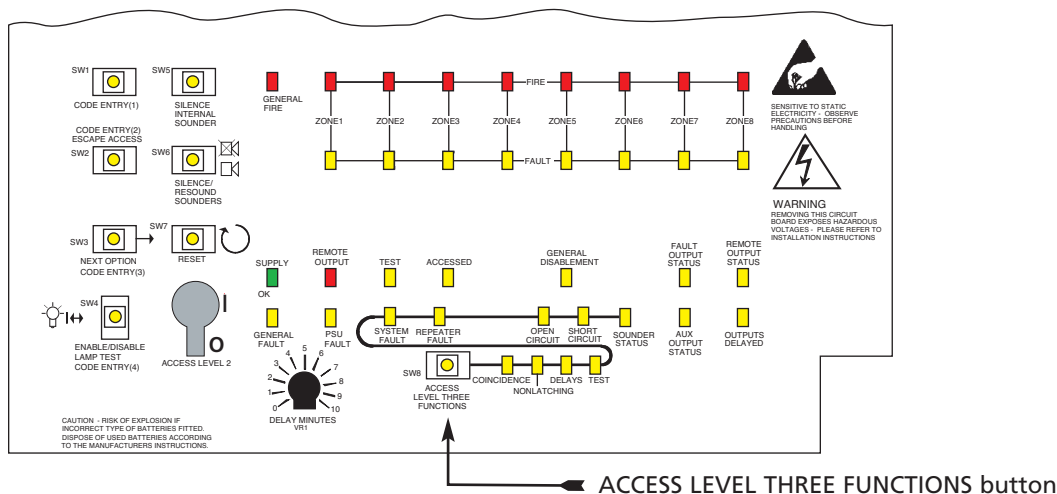

When the ACCESS LEVEL THREE FUNCTIONS button is pressed for the first time, the Accessed light will be lit steady and the first engineer function (COINCIDENCE) will be selected and indicated by its yellow light flashing (see right).

Every time the ACCESS LEVEL THREE FUNCTIONS button is pressed the next engineer function is selected.

Note: The engineer functions are graphically linked on the Main Control PCB by an 'S' shaped line (see right). Pressing the ACCESS LEVEL THREE FUNCTIONS button after the last selection (SOUNDER STATUS) returns the user to the first function (COINCIDENCE). To exit access level three at any time, press the ESCAPE ACCESS button.

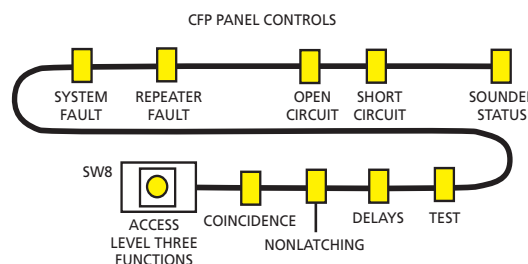

Notes:

1. Access level three functions that are relevant to zones temporarily use the Zone Fault lights to show which zones have been programmed for that function. This means any fault or disablement indication is suppressed until the programming of the relevant function is complete.
2. When the panel's lid is removed, it is still possible to access the panel's authorised user control, i.e. access level 2. This is done by entering the 2 1 4 3 entry code or, by turning the keyswitch to the 'I' position). For detailed information on the authorised user controls, please refer to the separate User Manual / Log Book.

To program coincidence (Note: This function is non-compliant with EN54-2)



1. Press the ACCESS LEVEL THREE FUNCTIONS button until the COINCIDENCE light flashes (any pairs of zones that are already programmed for coincidence will now have their Zone Fault lights lit steady).
2. To change the coincidence configuration press the NEXT OPTION button (Fault lights for zones 1 and 2 will flash slower than COINCIDENCE light if not programmed for coincidence, or at the same rate if they are).
3. If required, toggle between the two states by pressing the ENABLE/DISABLE button.
4. Confirm your selection by pressing the NEXT OPTION button. This will move to the next pair of zones (if available).
5. Repeat steps 3 and 4 until the process is complete.
6. To finish the function, press the ESCAPE ACCESS button or move onto the next programming function (NONLATCHING) by pressing the ACCESS LEVEL THREE FUNCTIONS button.

To program non-latching zones (Note: This function is non-compliant with EN54-2)



1. Press the ACCESS LEVEL THREE FUNCTIONS button until the NONLATCHING light flashes (any zones that are already programmed for non-latching operation will now have their Zone Fault lights lit steady).
2. To change the non-latching configuration press the NEXT OPTION button (zone 1's Fault light will flash slower than the NONLATCHING light if not programmed, or at the same rate if it is).
3. If required, toggle between the two states by pressing the ENABLE/DISABLE button.
4. To confirm your choice, press the NEXT OPTION button. This will move you to the next zone (if available).
5. Repeat steps 3 and 4 until the process is complete.
6. To finish the function, press the ESCAPE ACCESS button or move onto the next programming function (DELAYS) by pressing the ACCESS LEVEL THREE FUNCTIONS button.

To program delays

1. Press the ACCESS LEVEL THREE FUNCTIONS button until the DELAYS light flashes (any zones that are already programmed for delays will now have their Zone Fault lights lit steady, and similarly, if the Remote Output or Auxiliary Output are delayed, then their relevant status lights will be lit steady. **Note:** Any existing fault indications will be temporarily suppressed during this programming function. On exiting the function, the previous indications will be restored).
2. To change the delays configuration press the NEXT OPTION button (zone 1's Fault light will flash slower than the DELAYS light if not programmed, or at the same rate if it is).
3. If required, toggle between the two states by pressing the ENABLE/DISABLE button.
4. To confirm your choice, press the NEXT OPTION button. This will move you to the next zone (if available).
5. Repeat steps 3 and 4 until the zone selection process is complete.
6. Pressing the NEXT OPTION button when on the last zone will now select the Remote Output for editing. The output's current status will be shown by the Remote Output Status light, in the same way as for the zones.
7. If required, toggle between the two states by pressing the ENABLE/DISABLE button.
8. Pressing the NEXT OPTION button will now select the Auxiliary Output for editing. The output's current status will be shown by the Auxiliary Output Status light, in the same way as for the zones.
9. If required, toggle between the two states by pressing the ENABLE/DISABLE button.
10. Pressing the NEXT OPTION button will return the selection to zone 1.
11. Set the delay period which will apply to all delayed zones or outputs by adjusting the VR1 control on the Main Control PCB with a terminal screwdriver (this can be anything from 1 to 10 minutes), then press the ESCAPE ACCESS button or move onto the next programming function (TEST) by pressing the ACCESS LEVEL THREE FUNCTIONS button.

Note: Even if delays are programmed into the panel, the user can still decide not to use them. See the disablement section of the User Manual / Log Book for more details.

To program zones into test

1. Press the ACCESS LEVEL THREE FUNCTIONS button until the TEST light flashes (any zones that are already programmed for test will now have their Zone Fault lights lit steady).
2. To change the test configuration press the NEXT OPTION button (zone 1's Fault light will flash slower than the TEST light if not programmed, or at the same rate if it is).
3. If required, toggle between the two states by pressing the ENABLE/DISABLE button.
4. To confirm your choice, press the NEXT OPTION button. This will move you to the next zone (if available).
5. Repeat steps 3 and 4 until the process is complete.
Important: Before testing any of the zones you have programmed for test, you must first press the ESCAPE ACCESS button. Any zone(s) in test will now be lit steady and the General Test light will also be lit. Testing can now commence. Remember to take the relevant zones out of test when testing is complete.

To program the sounders function

1. Press the ACCESS LEVEL THREE FUNCTIONS button until the SOUNDER STATUS light flashes.
If the SOUNDER STATUS light flashes three times quickly with a longer off period, then an alarm in a new zone will resound the sounders. If the SOUNDER STATUS light flashes with equal on-off periods, then an alarm in a new zone will NOT resound the sounders.
2. If required, toggle between the two states by pressing the ENABLE/DISABLE button.
3. To finish the function, press the ESCAPE ACCESS button, or move onto the next programming function (COINCIDENCE) by pressing the ACCESS LEVEL THREE FUNCTIONS button.

Note: 'SYSTEM FAULT', 'REPEATER FAULT', 'OPEN CIRCUIT' and 'SHORT CIRCUIT' options are for fault diagnosis purposes, as detailed on pages 18 to 22.



The relevant part of the System Set-Up Data chart in the User Manual / Log Book must be updated if you implement or make any changes to the coincidence, non-latching zones, delays, or program sounders functions.

FAULT DIAGNOSIS

Fault indications

When a fault occurs on a critical part of the fire alarm system, the panel responds by activating its internal sounder and illuminating the General Fault light and any other Fault light(s) relating to the fault. The panel's fault output will also activate (provided it has not been disabled).

The type of faults typically indicated at the fire alarm panel are highlighted below. A more precise diagnosis of fault conditions is available at access level three (the summaries below refer to the sections you should read later in this manual for further information). Unless otherwise stated, repairing any particular fault condition will automatically clear the fault from the panel. If the panel is reset whilst faults still exist, the faults will reappear after a short period of time.

Note: It is possible to mute the panel's internal sounder at any time by momentarily pressing the SILENCE INTERNAL SOUNDER button.

General Fault

This light flashes yellow when there is a fault on any part of the fire alarm system. It is always lit in tandem with at least one other Fault light which displays precise information on the type of fault detected.

Zone Faults

All of the panel's zone circuits are monitored for open and short circuit faults and detector head removal (unless there is an alarm condition or the zone is in test or disabled). All faults are indicated by the relevant Zone Fault light pulsing yellow.

For advice on how to correct this fault see page 19, section 1.1.

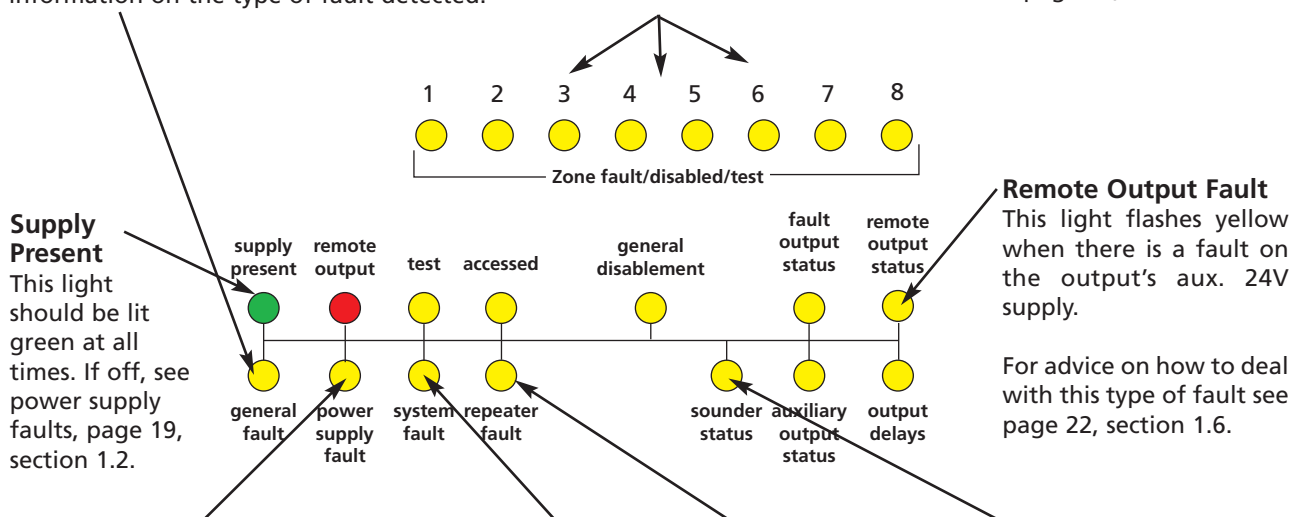

Supply Present

This light should be lit green at all times. If off, see power supply faults, page 19, section 1.2.

Remote Output Fault

This light flashes yellow when there is a fault on the output's aux. 24V supply.

For advice on how to deal with this type of fault see page 22, section 1.6.

Power Supply Fault

This light flashes yellow when one or more of the following has occurred:

- 1) The Mains supply is too low or has failed completely.
- 2) Mains fuse (F1) has ruptured.
- 3) Battery fuse (F2) has ruptured.
- 4) The battery supply voltage is too low.
- 5) The panel's power supply unit is faulty.

For advice on how to correct this fault see page 19, section 1.2.

System Fault

This light flashes yellow when one or more of the following has occurred:

- 1) There is a microprocessor "watchdog" fault.
- 2) The microprocessor's site memory has been corrupted.
- 3) The microprocessor's program menu has been corrupted.
- 4) The Main Control PCB is faulty.

For advice on how to correct this fault see page 21, section 1.3.

Repeater Fault

This light flashes yellow when the master panel cannot communicate with one or more repeater panels (if fitted).

For advice on how to correct this fault see page 22, section 1.4.

Sounder Fault

All sounder circuits are monitored periodically for open and short circuit faults (unless disabled or in an alarm condition). If any faults are detected, this light pulses yellow.

For advice on how to correct this fault see page 22, section 1.5.

CFP 2/4/8 ZONE LPCB APPROVED FIRE ALARM PANEL

1.1 Zone faults

- To find out if an open circuit fault has occurred on a detector zone:

1. Remove the panel's lid using the Torx key provided and press the ACCESS LEVEL THREE FUNCTIONS button on the Main Control PCB to gain access to the panel's engineer functions (see below).

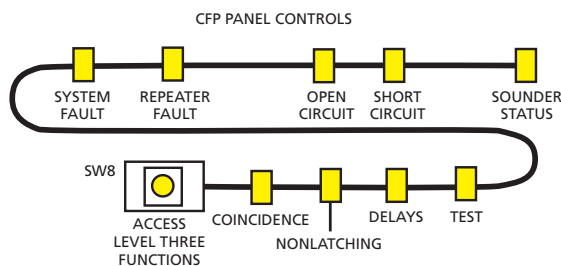

2. Continue pressing the ACCESS LEVEL THREE FUNCTIONS button until the OPEN CIRCUIT light pulses. Any existing Zone Fault lights are suppressed and the zone light(s) for any zone(s) with an open circuit fault are illuminated, e.g. if the wiring on zone 6 is broken, zone 6's Fault light will be lit.

- To find out if a short circuit fault has occurred on a detector zone:

1. Follow steps 1 and 2 detailed above until the SHORT CIRCUIT light pulses.
2. Any existing Zone Fault lights are suppressed and the zone light(s) for any zone (s) that have a short circuit fault are illuminated, e.g. if the wiring on zone 4 has been shorted, zone 4's Fault light will be lit.

Suggested actions:

1. Disconnect the faulty detector zone completely and refit the end-of-line capacitor at the panel. If the fault condition clears this confirms there is a wiring fault.
2. Refit and double check the wiring and the end-of-line capacitor on the zone. Trace the fault with consideration for the type of fault indicated (see above).
Note: A common short circuit fault is a detector head badly seated in a base which is not making a true connection.

1.2 Power supply faults

A power supply fault indicates one, or more, of the following faults. Page 11 of this manual **must** be referenced when carrying out any of the suggested action procedures described below.

- The Mains supply voltage is too low or has failed completely, the Mains fuse (F1) has ruptured or the PSU has failed.

Symptoms: The panel runs on batteries, but not on Mains.

Suggested actions:

1. Taking all due precautions, check Mains voltages are within range (see Technical Specifications, page 24) by probing Live and Neutral connections at connector block (CONN1). If not within range, repair Mains supply.
2. If within range and the red Hazardous Voltages Present light is not lit, check the Mains fuse (F1).
3. If the fuse is intact, the red Hazardous Voltages Present light on the Power Supply PCB may, or may not, be lit. The PSU is faulty and should be replaced. Isolate the Mains supply and wait for the red Hazardous Voltages Present light to extinguish before replacing the Power Supply PCB.

CFP 2/4/8 ZONE LPCB APPROVED FIRE ALARM PANEL

- **The battery fuse (F2) is ruptured.**

Symptoms: The panel runs on Mains, but not on batteries.

Suggested actions:

1. Isolate the Mains supply and disconnect the batteries.
2. Remove the Main Control PCB and check the battery fuse (F2) on the Power Supply PCB for continuity.
3. If ruptured check the Power Supply and Main Control PCBs for signs of damage. If none found, replace fuse with the correct type, ensuring the fuse clip is not damaged when re-inserting the fuse.
4. Refit the Main Control PCB and reconnect the batteries.
5. If the green Supply Present light is lit, reconnect the Mains supply and check that the power supply fault has cleared. If the Supply Present light is not lit, either the Power Supply PCB or the Main Control PCB is faulty and should be replaced.
6. If the battery fuse (F2) is intact, proceed to check the battery voltage/condition (see below).

- **The battery voltage is too low, or in poor condition.**

Symptoms: The panel runs on Mains, but may or may not run on batteries.

If the Mains supply has failed and the battery supply has been discharged to the point where the voltage is too low (i.e less than 21V), the panel will automatically turn off to avoid damaging the batteries by allowing them to deep discharge. The panel will not restart unless fresh, fully charged batteries are connected, or the Mains supply is restored.

If the Mains supply has not failed, but the total battery voltage is less than 21V, the PSU may not charge the batteries to avoid damage to the charging circuit. If the batteries can be charged, the panel will still show a power supply fault until they have sufficient charge, at which point the power supply fault will automatically be cleared. Depending on battery size and the depth of discharge, this may take several hours. **If the batteries are in poor condition they must be replaced.**

If the batteries (or their leads) are high resistance, then this will also result in a PSU fault. This fault may occur due to:

- batteries that have been stored for many months
- low quality batteries
- old batteries
- loose/poor connections to the batteries.

If the batteries are in good condition and all the other checks have been performed and no faults found, the Power Supply PCB is faulty and should be replaced. **Note:** Batteries that are not connected, connected in reverse, or with opposite polarities will also cause a power supply fault condition.

- **Supply Present light not lit.**

If the Supply Present light is not lit one of the following faults has occurred:

1. Both the Mains supply and the standby batteries have failed. This could be because the Mains supply has failed and the batteries have been exhausted.

Suggested action: Restore the Mains supply and the Supply Present light should come back on. However, if the batteries are discharged this will be recognised as a fault by the panel and indicated as such. See 'Battery voltage too low' above.

2. The Power Supply PCB, the Main Control PCB and/or the cable that connects them is faulty. If the Mains supply is present (indicated by the red Hazardous Voltages Present light being lit on the Power Supply PCB), check that the connector cable between the Power Supply PCB and the Main Control PCB is fully inserted at both ends. If so, either the Power Supply PCB and/or the Main Control PCB and/or the connector cable are faulty and should be replaced.

CFP 2/4/8 ZONE LPCB APPROVED FIRE ALARM PANEL

1.3 System faults

System faults are unique in that they do not automatically clear when rectified. Three different types of system fault can occur; watchdog fault, site memory corruption fault or PLL (phase lock loop) fault.

• To find out which type of system fault has occurred:

1. Remove the panel's lid using the Torx key provided and press the ACCESS LEVEL THREE FUNCTIONS button on the Main Control PCB to gain access to the panel's engineer functions (see below). **Note:** If pressing the ACCESS LEVEL THREE FUNCTIONS button (or any other button) does not cause any change in state, the Main Control PCB is faulty and must be replaced.

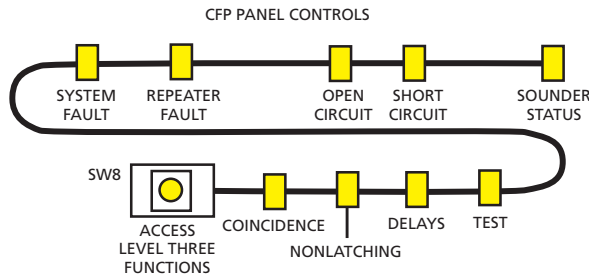

2. Continue pressing the ACCESS LEVEL THREE FUNCTIONS button until the SYSTEM FAULT light pulses.

If there is a **Watchdog Fault**, Zone 1's Fault light will be lit.

If there is a **Site Memory Corruption Fault**, Zone 2's Fault light will be lit.

If there is a **PLL Fault**, Zone 3's Fault light will be lit.

For a detailed description of what each fault is, and suggested action on how to rectify it, see below:

• **Watchdog Fault**

This type of system fault occurs when the panel's microprocessor has failed to operate correctly. In this case the panel's 'Watchdog' circuit will attempt to bring the microprocessor back under control and return all outputs and indicators to their normal state. If the watchdog cannot restart the microprocessor then the General Fault and System Fault lights will be cycle continuously, plus the panel's internal sounder will activate.

Suggested action:

Press the panel's RESET button and, if still in access level three, the ESCAPE ACCESS button. This should clear the fault. If the fault persists, the Main Control PCB is faulty and must be replaced.

• **Site Memory Corruption Fault**

This type of system fault occurs when site specific data held in the panel's microprocessor is found to be corrupt.

Suggested action:

1. Check all the site specific data (delays, disablements, etc) at user and engineering levels. The System Set-Up Data Chart in the User Manual / Log Book (page 13) includes relevant set-up information.
2. If errors are found, reprogram the panel accordingly to clear the corruption.
3. If no errors are found, temporarily change some data, e.g. disable zone 1, exit user mode and then re-enable zone 1 to return to the original settings. This should clear the fault. If the fault persists, the memory is damaged and the Main Control PCB must be replaced.

• **PLL Fault**

This type of system fault occurs as a result of a momentary disturbance in the panel's microprocessor.

Suggested action:

Resetting the panel should clear the fault. If the fault persists, the Main Control PCB is faulty and must be replaced.

CFP 2/4/8 ZONE LPCB APPROVED FIRE ALARM PANEL

1.4 Repeater faults

- To find out which of the repeater panels are faulty:
 - Remove the panel's lid using the Torx key provided and press the ACCESS LEVEL THREE FUNCTIONS button on the Main Control PCB to gain access to the panel's engineer functions (see below).

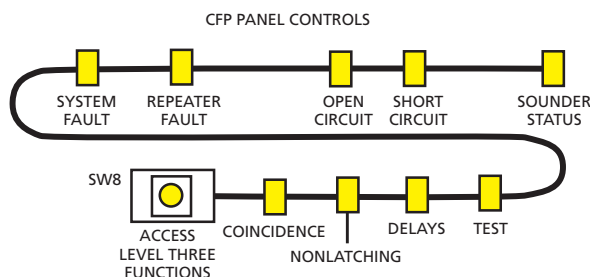

- Continue pressing the ACCESS LEVEL THREE FUNCTIONS button until the REPEATER FAULT light pulses. Any existing Zone Fault lights are suppressed and the zone light(s) corresponding to the repeaters in fault are illuminated, e.g. if repeaters 2 and 7 are faulty, the Fault lights for zones 2 and 7 will be lit. To exit access level three, press the ESCAPE ACCESS button at any time.

Suggested action: Refer to the Repeater Panel Instructions for repeater fault-finding advice.

1.5 Sounder faults

- To determine which of the panel's four sounder circuits are faulty:
 - Disconnect each sounder circuit from the Main Control PCB in turn and measure the resistance between the two wires. A good circuit will present only the end-of-line resistor value. Any other resistance value shows a fault.
 - If the readings from all sounder circuits are correct, take their end-of-line resistors and connect them to the sounder circuits at the panel without the sounder circuit wiring. If the fault still persists, the panel is faulty and must be replaced.
 - If a sounder circuit fault is detected, correct the fault and reconnect the sounder circuit. The sounder fault will automatically clear within 60 seconds.

Note: If the sounder circuit is shorted and the alarm voltage applied, the relevant sounder fuse will trip. When the fault is removed, the fuse will automatically reset.

1.6 Remote output faults

If the panel's 24V auxiliary output (which is typically used to supply relays switched by the remote output) is subject to current overload, its protection fuse will trip. This will result in the remote fire output showing a fault condition by flashing its respective light.

Repairing the fault will reset the fuse and clear the associated Fault light.

MAINTENANCE

Periodic system maintenance should be carried out on the system as prescribed in the local design, maintenance and installation regulations.

The Fire Alarm panel's standby batteries should be checked for integrity of the connections, deposits indicating venting, and a periodic load test with the Mains supply disabled to ensure adequate battery capacity. Both batteries should be renewed if there is any doubt about their integrity.

STANDBY BATTERY CALCULATION GUIDE

The standby time of the fire alarm panel, after the Mains has failed, depends on the quiescent loading of the panel, the alarm load of the panel and the capacity of the batteries.

Note: LPCB approved systems must use 3.2Ah batteries (YUASA NP3.2-12).

To determine the capacity of batteries required for any given standby period, the following formula should be used:

$$\text{Standby Time in Ah} = 1.25 \times [(T \times A) + H \times (P + Z)]$$

The multiplier 1.25 is present to account for lost capacity over the life of the batteries.

H = Number of hours standby required

P = The quiescent current of the panel = 0.025A

This figure is with the Mains failed, internal sounder active and the Power Supply and General Fault lights lit. If there are other quiescent drains on the panel then these must be included.

Z = The total quiescent current of all zone devices

As a guideline, the quiescent current of most modern detectors is typically 0.00005A (50µA), and that of manual call points is zero. To obtain accurate figures consult the device manufacturers' own specifications.

A = The total alarm current of the sounders (plus any other devices connected to other alarm outputs).

T = The amount of time in hours required for the alarm (most commonly being half an hour).

Example 1:

The panel has 70 detectors each consuming 50µA each, 20 sounders at 20mA each, the required standby time is 24 hours and the required alarm time is 0.5 hours.

$$Z = 70 \times 0.00005 = 0.0035A$$

$$P = 0.025A$$

$$A = 20 \times 0.02 = 0.4A$$

$$H = 24$$

$$T = 0.5$$

$$\text{Standby Time in Ah} = 1.25 \times [(0.5 \times 0.4) + 24 \times (0.025 + 0.0035)] = 1.1Ah.$$

Therefore, batteries with at least 1.1Ah capacity are required.

Example 2:

The panel has 100 detectors each consuming 50µA each, 40 sounders at 20mA each, the required standby time is 72 hours and the required alarm time is 0.5 hours.

$$Z = 100 \times 0.00005 = 0.005A$$

$$P = 0.025A$$

$$A = 40 \times 0.02 = 0.8A$$

$$H = 72$$

$$T = 0.5$$

$$\text{Standby Time in Ah} = 1.25 \times [(0.5 \times 0.8) + 72 \times (0.025 + 0.005)] = 3.2Ah$$

Therefore, batteries with at least 3.2Ah capacity are required.

CFP 2/4/8 ZONE LPCB APPROVED FIRE ALARM PANEL

TECHNICAL SPECIFICATION

POWER SUPPLY SPECIFICATION	
Mains supply voltage	230V 50/60Hz
Mains rated current	350mA maximum
Internal power supply	19V - 28.5V (27V nominal). Ripple 7V maximum (battery fault)
Total output current limited to	1.5A @ 230Vac (ImaxA = 146mA)
Maximum internal battery resistance	Ri max = 1.5Ω
Supply and battery charger monitored for failure	YES (battery charger is also temperature compensated)
Batteries monitored for disconnection & failure	YES
Batteries protected against deep discharge	YES (Deep discharge cut off approx. 21 volts)
Max. battery size and type	2 x 12V 3.2Ah VRLA type, connected in series. Use YUASA NP3.2-12 for LPCB approved systems. Minimum battery size 1.2Ah.
Mains fuse (F1)	240V 1A HRC ceramic 20mm compliant with IEC (EN60127 PT2)
Battery fuse (F2)	1.6A F 20mm compliant with IEC (EN60127 PT2)
Current draw from battery (Mains failed)	1.5A maximum
DETECTOR CIRCUIT SPECIFICATION	
Number of circuits	2, 4 or 8 (1 zone per circuit) depending on model purchased
Max. cable length per circuit	500 metres
Line monitored for open circuit and short circuit	YES - DC monitoring
Line monitored for detector removal	YES. End-of-line monitoring device modules provided.
Maximum allowable impedance (each conductor)	20Ω
Maximum cable capacitance (per circuit)	0.27μF
Call point resistor value	470 to 680Ω
Max. number of smoke/heat detectors	25 per zone
Max. combined no. of detectors & manual call points	32 per zone
SOUNDER CIRCUIT SPECIFICATION	
Number of circuits	4
End-of-line (EOL) resistor value	6800Ω 5% Tol. 0.25W (blue, grey, red, gold)
Each circuit monitored for open and short circuit	YES - Reverse voltage DC monitoring. Indicated by common fault.
Alarm voltage	27VDC maximum, 20VDC minimum (final battery voltage)
Sounder circuit fuses	Each circuit protected by fuses (200mA min. hold current; 400mA max. trip current; approx. 50mA when tripped. Reset when faults removed).
Maximum total sounder output current to all outputs	4 x 200mA = 800mA
Maximum No. of bells @ 25mA	32
Maximum No. of electronic sounders @ 20mA	40 (sounders must be polarised)
AUXILIARY OUTPUTS (Open Collector Type)	
Reset auxiliary output (RESET)	Non monitored, open collector type. Active during reset cycle.
Remote auxiliary output (REM)	Non monitored, open collector type. Active during any fire condition (provided all relevant delays have expired).
Max. sink current	30mA each
Max open circuit voltage	27Vdc
24V aux. power output (for use with the above)	This output is protected by a resettable fuse (100mA min. hold current). Fuse resets when fault removed.
AUXILIARY OUTPUTS (Relay Output Type)	
Auxiliary relay output (AUX)	Voltage-free single pole changeover
Fault relay output (FAULT)	Voltage-free single pole changeover
Max. switching current	1A
Max. switching voltage	30Vdc
AUXILIARY INPUTS	
Class Change (makes sounders sound continuously)	Connect to 0V to trigger. Max input voltage 27V (non-latching).
Alert (makes sounders pulse intermittently)	Connect to 0V to trigger. Max input voltage 27V (non-latching).
DIMENSIONS	
Physical size and weight	Size (OD) = 380 x 235 x 90mm approx. Weight=1.75kg (without batteries)
OPERATING CONDITIONS	
The components are selected to operate within their specification when the environmental conditions outside the enclosure comply with class 3k5 of IEC 721-3-3 : 1978. Temperature range: -5 to +40°C. Maximum relative humidity: 95%.	